

### FEATURES

- Trench MOS schottky barrier diode
- Low forward voltage drop
- Low profile - typical body height 1.1 mm
- High temperature soldering guaranteed: 260°C/10 seconds
- RoHS compliant
- Halogen-free according to IEC 61249-2-21 definition

### TO-277B

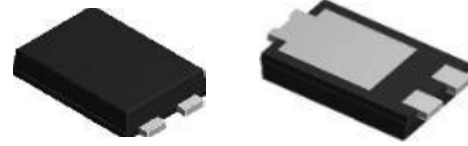

RoHS  
COMPLIANT

HALOGEN  
FREE

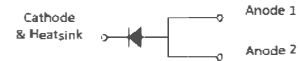

### MECHANICAL DATA

- Case: TO-277B
- Case material: molding compound meets UL 94V-0 flammability rating

### TYPICAL APPLICATION

General purpose use in low voltage high frequency inverters, freewheeling, DC/DC converters, and polarity protection applications.

### MAXIMUM RATINGS

$T_A=25^\circ\text{C}$  unless otherwise noted

Parameter	Symbol	Value	Unit
Repetitive Peak Reverse Voltage	$V_{RRM}$	120	V
Average Forward Rectified Current	$I_{F(AV)}$	15	A
Peak forward surge current (8.3 ms single half sine-wave superimposed on rated load)	$I_{FSM}$	250	A
Operating Junction Temperature Range	$T_J$	-55 to +150	$^\circ\text{C}$
Storage Temperature Range	$T_{STG}$	-55 to +150	$^\circ\text{C}$

### ELECTRICAL CHARACTERISTICS

$T_A=25^\circ\text{C}$  unless otherwise noted

Parameter	Test Conditions	Symbol	Value		Unit
			Typ.	Max.	
Forward Voltage @ $I_F=15\text{A}$	$T_A=25^\circ\text{C}$	$V_F$	0.75	0.79	V
	$T_A=125^\circ\text{C}$		0.67	0.71	
Reverse Current @ $V_{RRM}$	$T_A=25^\circ\text{C}$	$I_R$	20	70	$\mu\text{A}$
	$T_A=125^\circ\text{C}$		10	50	mA
Typical Thermal Resistance		$R_{\theta JA}$	68		$^\circ\text{C/W}$



### RATINGS AND CHARACTERISTIC CURVES

$T_A=25^\circ\text{C}$  unless otherwise noted

**FIG.1: Forward Output Current Derating Curve**

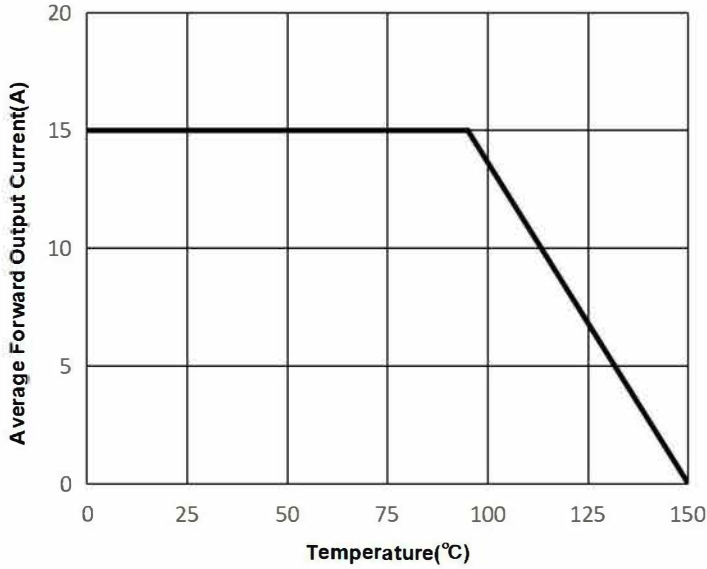

**FIG.2: Maximum Non-Repetitive Peak Forward Surge Current**

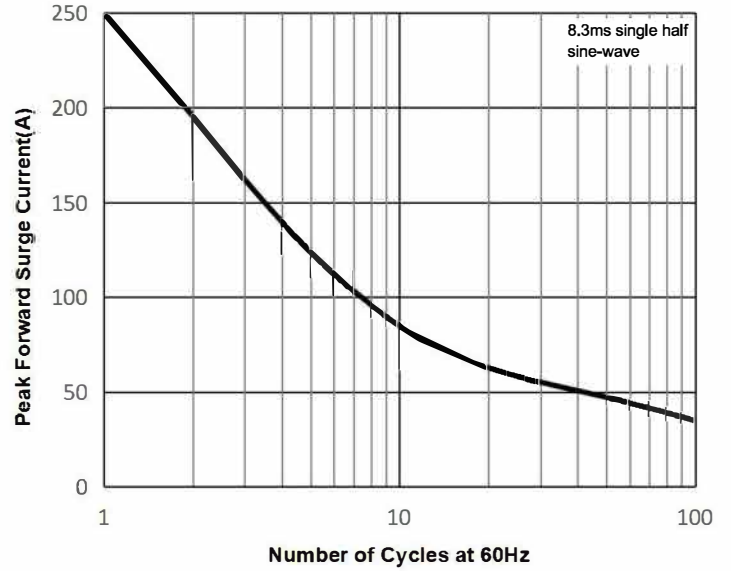

**FIG.3: Typical Forward Characteristics**

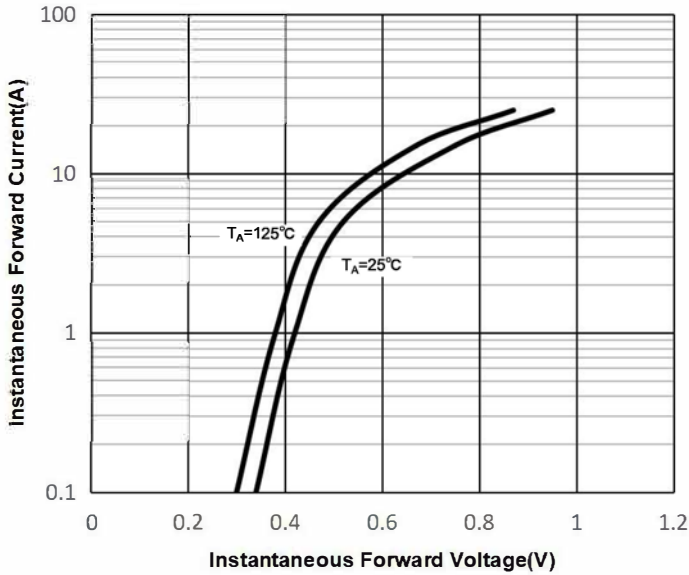

**FIG.4: Typical Reverse Characteristics**

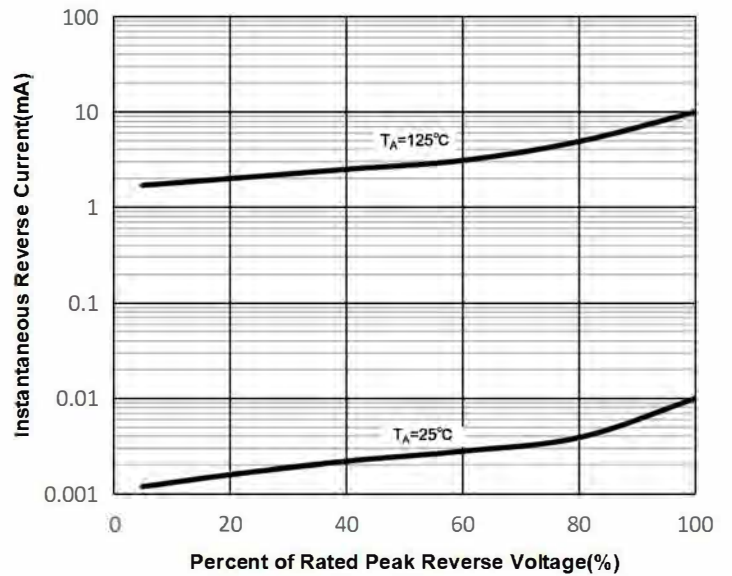

### PACKAGE OUTLINE DIMENSIONS

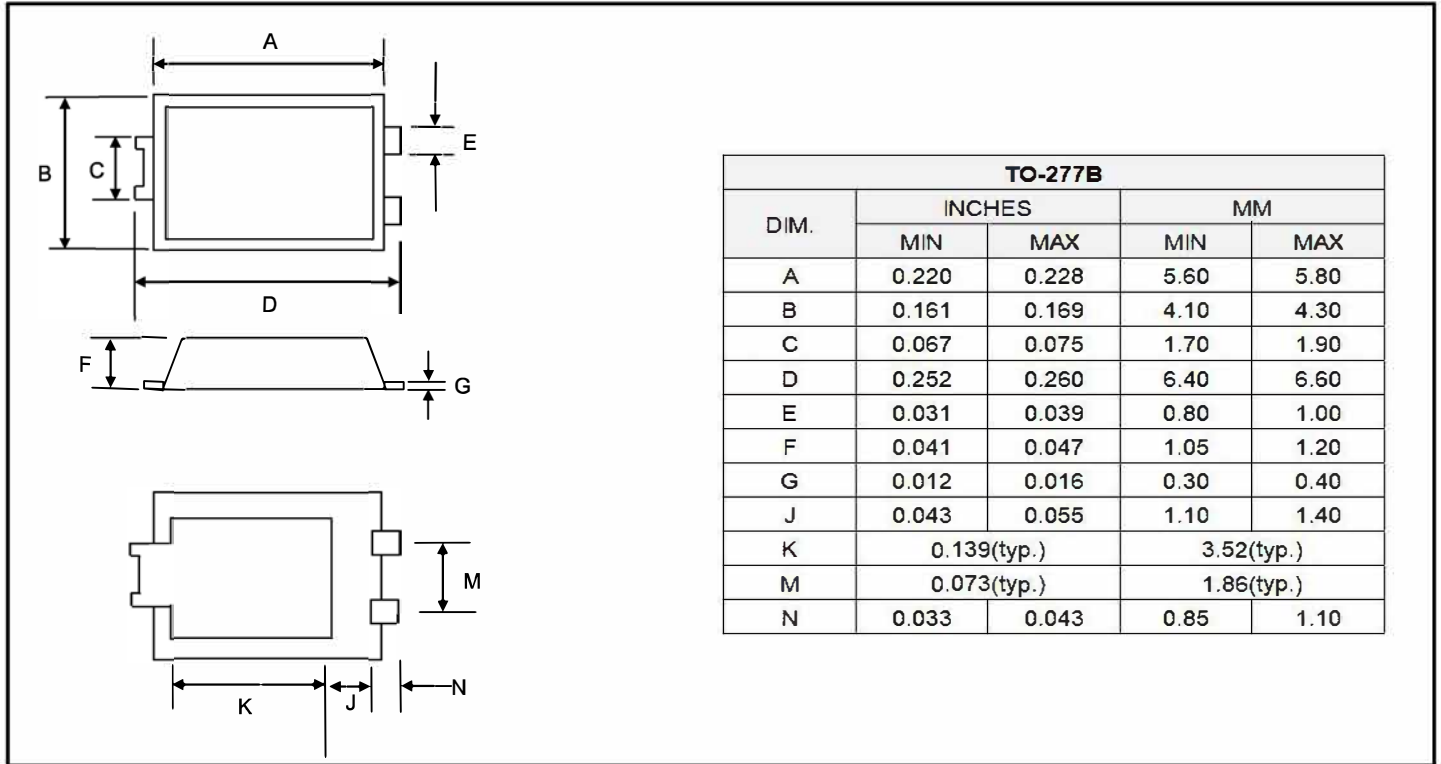

### PACKING INFORMATION

Package	Reel(PCS)	Inner Box(PCS)	Carton(PCS)
TO-277B	5,000	10,000	80,000



## DISCLAIMER

1. Above specification may be changed without notice. MHCHXM will reserve authority on material change for above specification.
2. The graphs shown in this datasheet are representing typical data only and do not show guaranteed values.
3. When using this product, please observe the absolute maximum ratings and the instructions for use outlined in these specification sheets. MHCHXM assumes no responsibility for any damage resulting from use of the product which does not comply with the absolute maximum ratings and the instructions included in these specification sheets.
4. These specification sheets include materials protected under copyright of MHCHXM. Reproduction in any form is prohibited without the specific consent of MHCHXM.
5. This product is not intended to be used for military, aircraft, automotive, medical, life sustaining or life saving applications or any other application which can result in human injury or death. Please contact authorized MHCHXM sales agent for special application request.
6. Statements regarding the suitability of products for certain types of applications are based on MHCHXM's knowledge of typical requirements that are often placed on MHCHXM products in generic applications. Such statements are not binding statements about the suitability of products for a particular application. It is the customer's responsibility to validate that a particular product with the properties described in the product specification is suitable for use in a particular application. Parameters provided in datasheets and/or specifications may vary in different applications and performance may vary over time. All operating parameters, including typical parameters, must be validated for each customer application by the customer's technical experts. Product specifications do not expand or otherwise modify MHCHXM's terms and conditions of purchase, including but not limited to the warranty expressed therein.
7. This publication supersedes & replaces all information previously supplied. For additional application information, please visit our website <http://www.jshxm.com> , or consult your nearest MHCHXM's sales office for further assistance.

